

ProGreen Plus 20ft CoverShed

ASSEMBLY INSTRUCTIONS

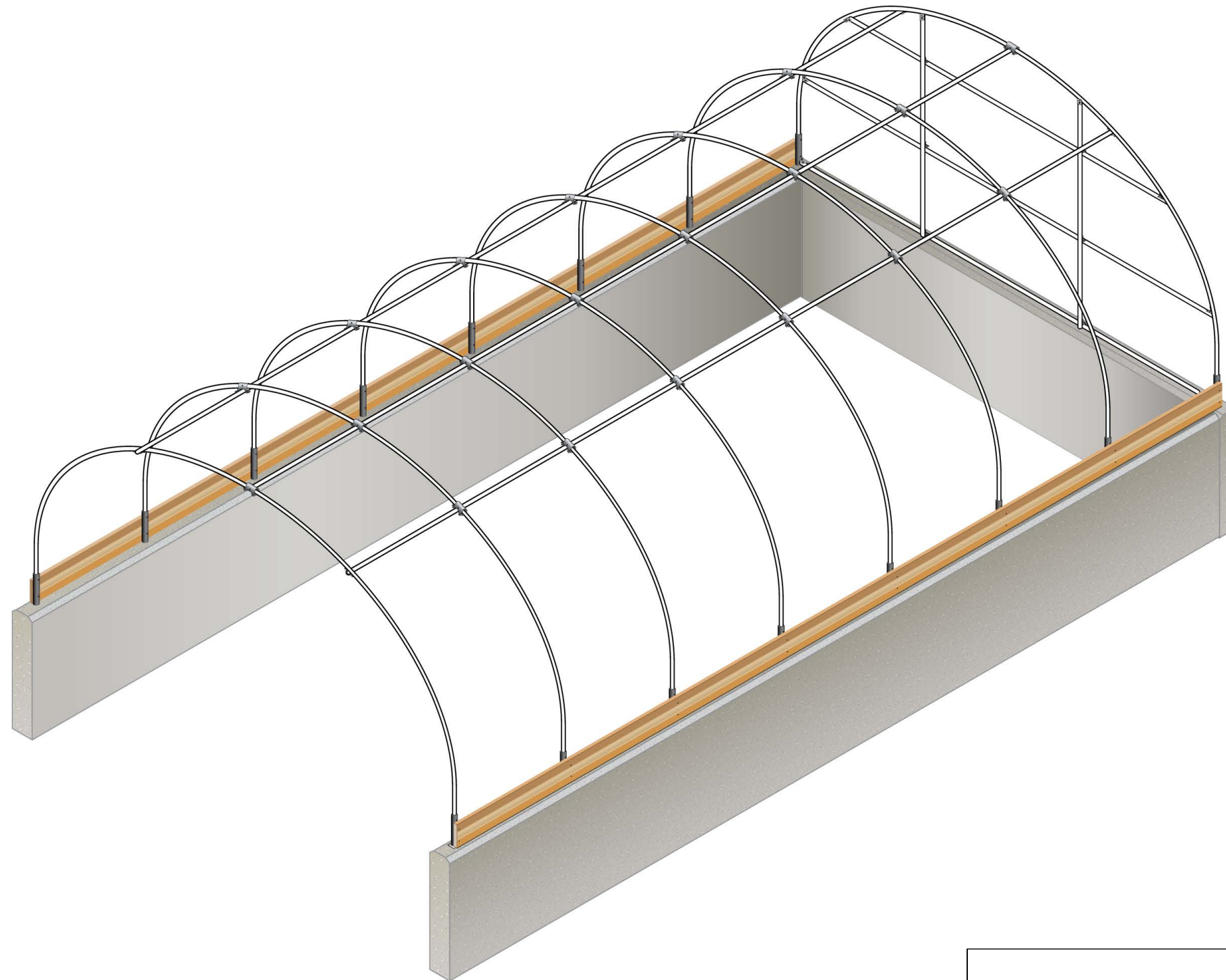

Note: Baseboard and foundation wall by others

This manual should be referenced as a generic set of instructions. Some details shown may not correspond exactly with your project.

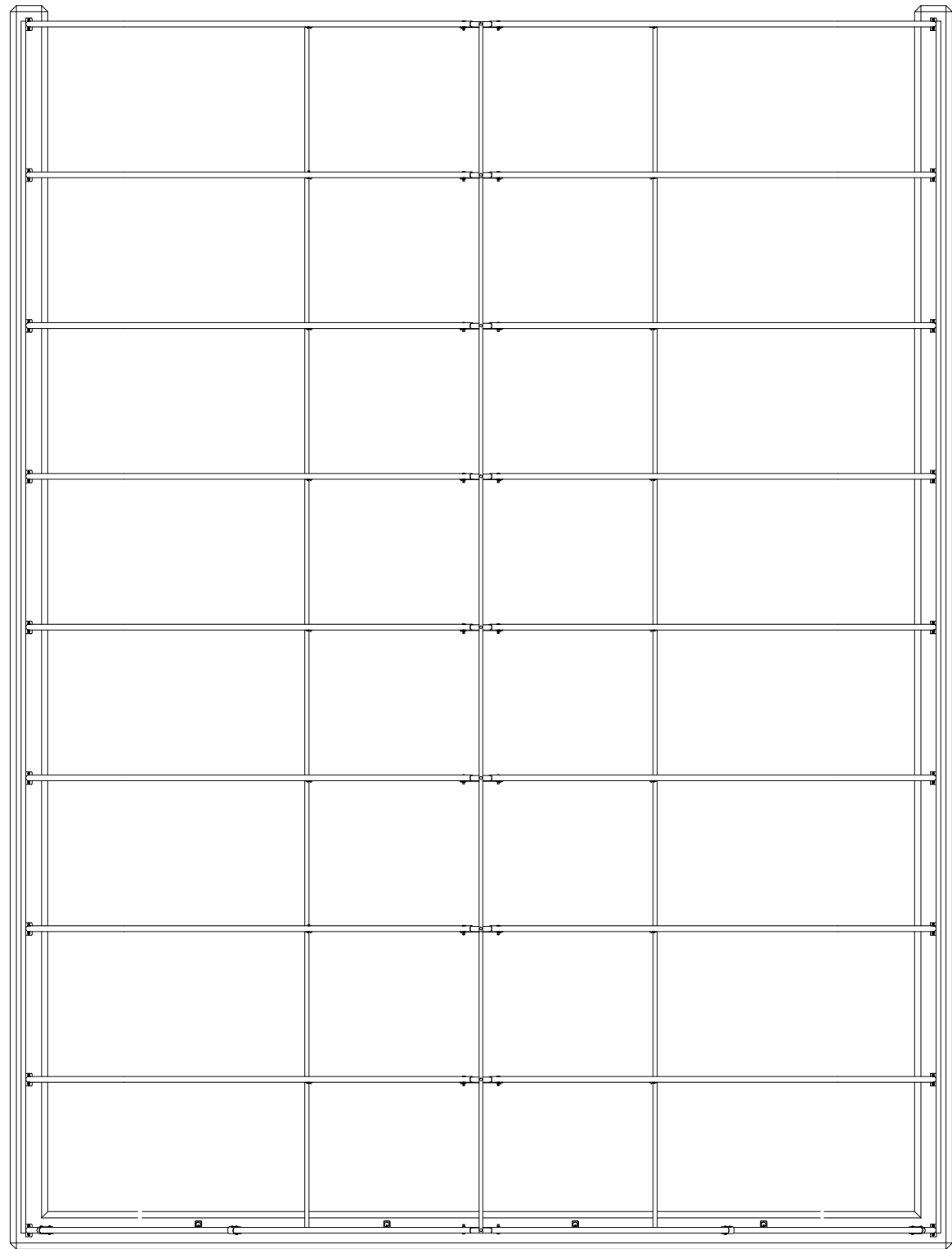

Note: Baseboard and foundation wall by others

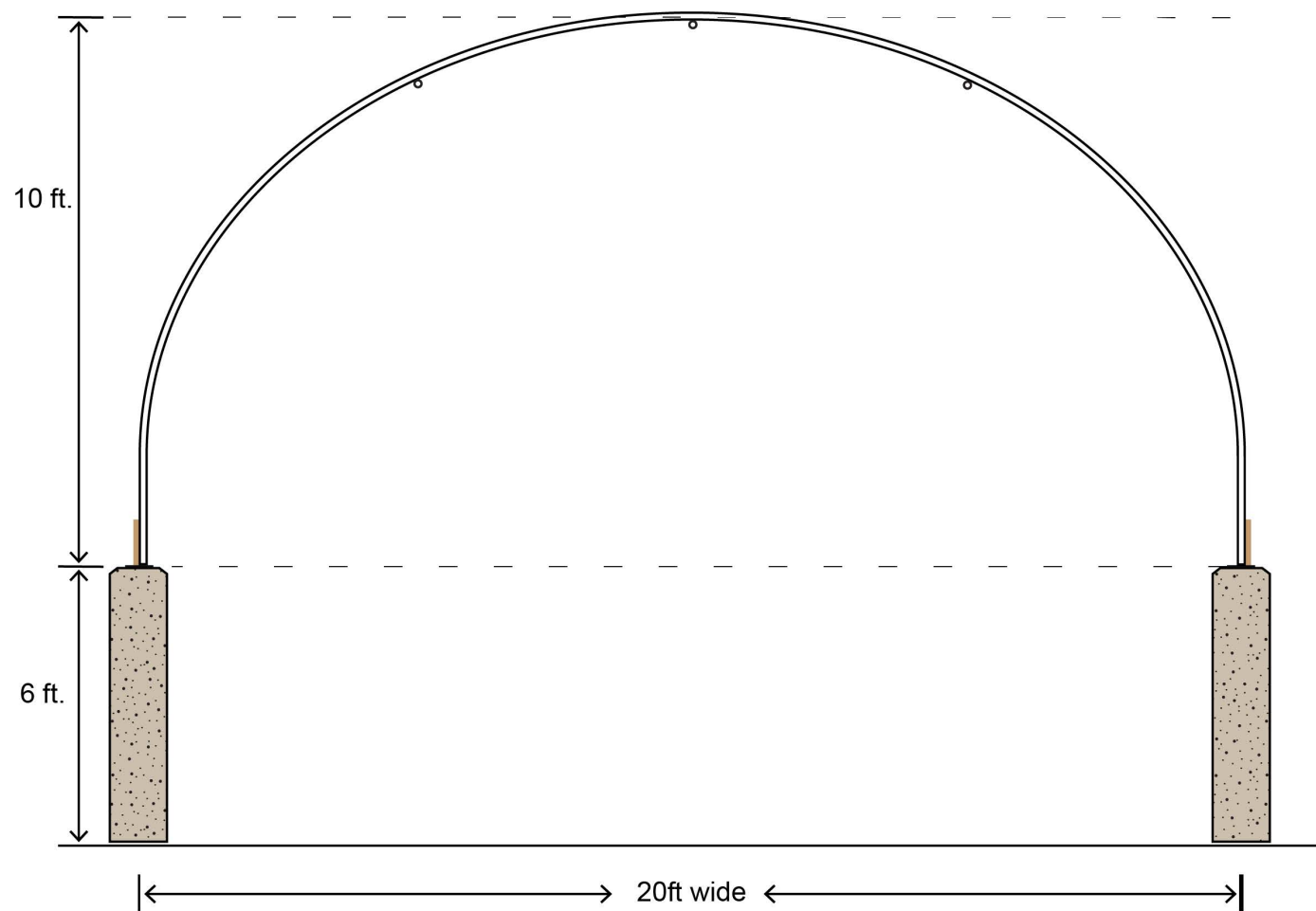

Post w/ baseplate attached to concrete wall - fastener by others

1.66 O.D. post

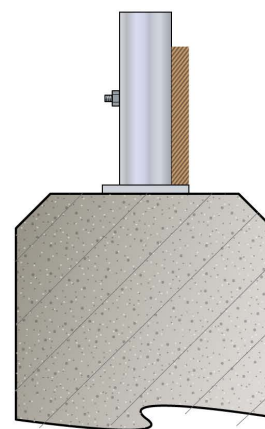

Baseboard (by others)

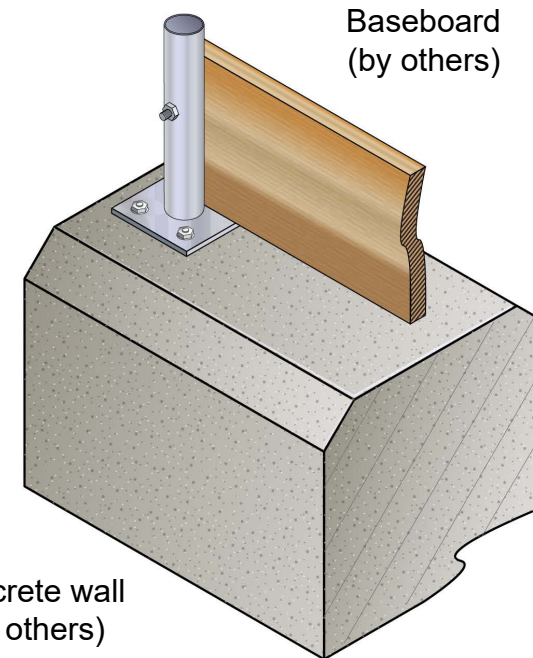

Concrete wall (by others)

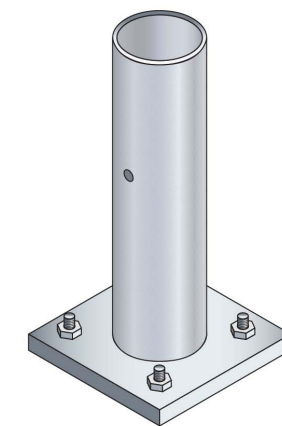

Purlins

Attach remaining purlins to underside of bows at pilot hole locations. Fasten to each bow using a pipe strap and three screws per connection.

Recommended purlin location is shown below. Exact position of purlins is not critical, as long as they attach to the same location on each bow.

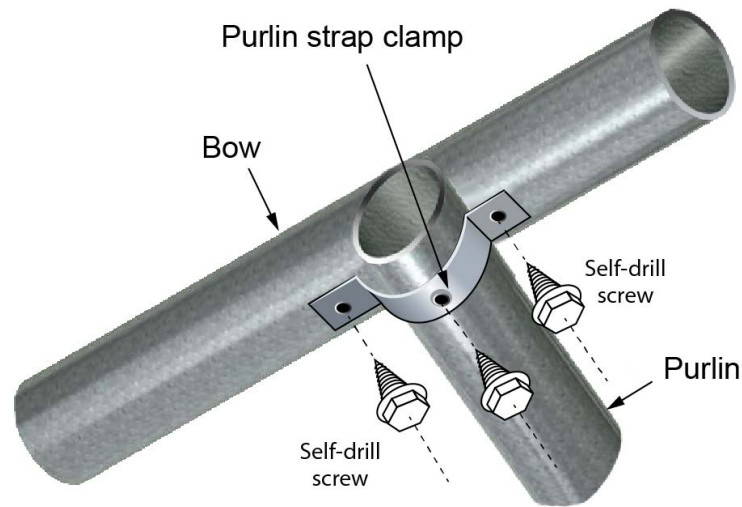
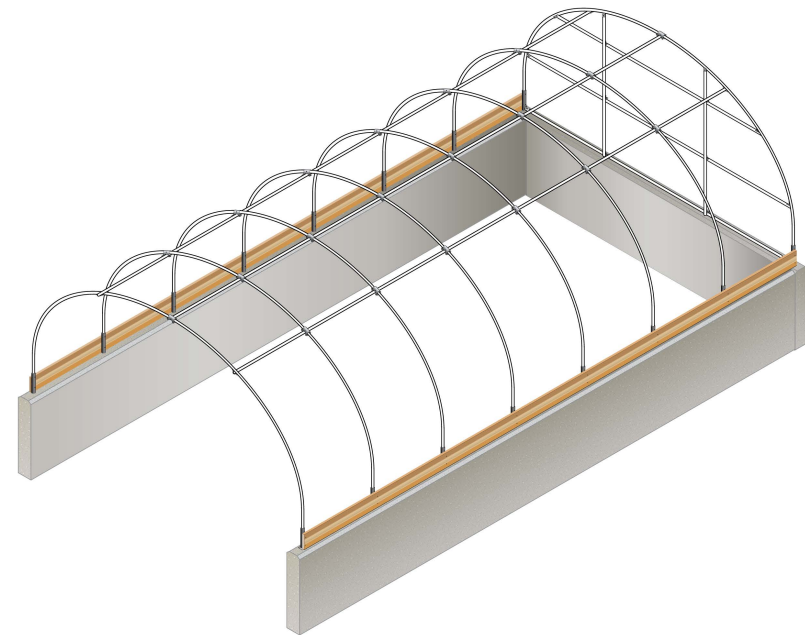

PURLIN END STRAP

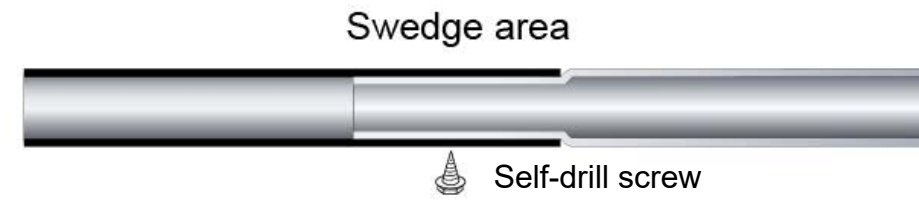

PURLIN SWEDGE DETAIL

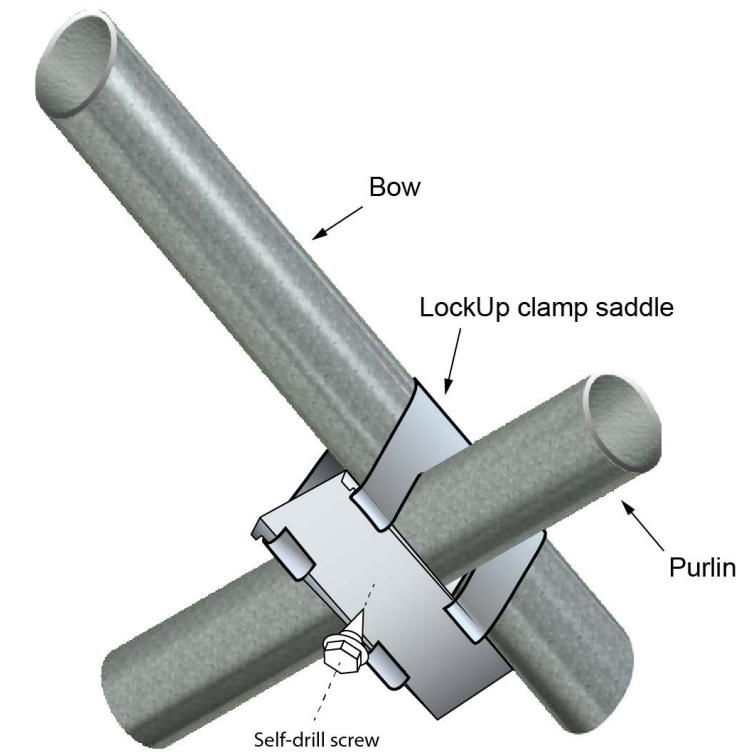
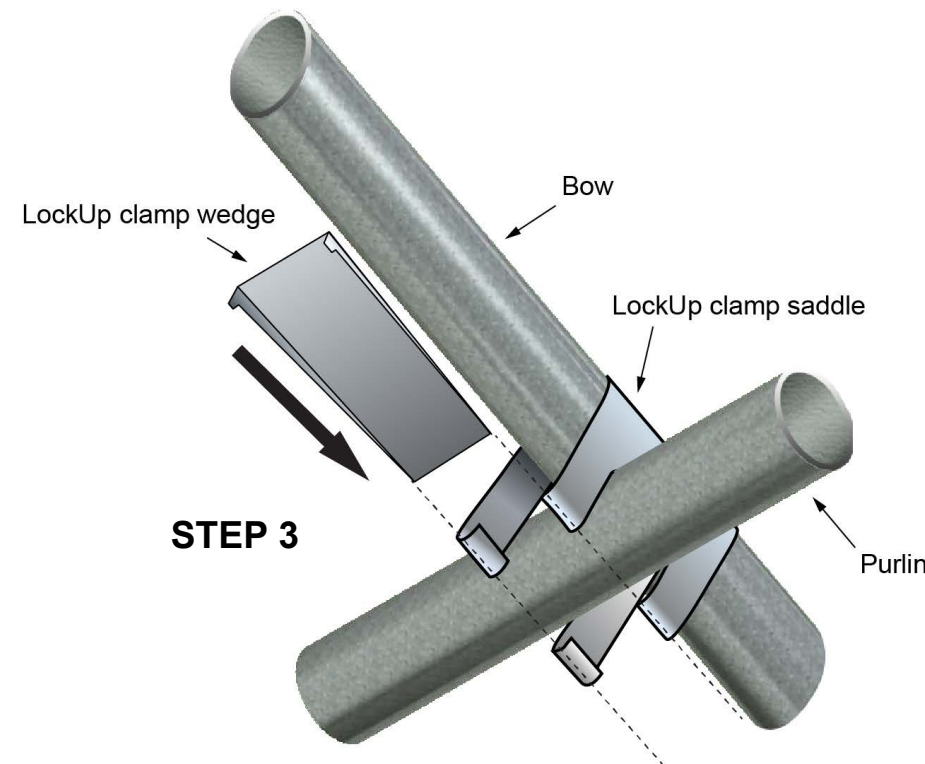
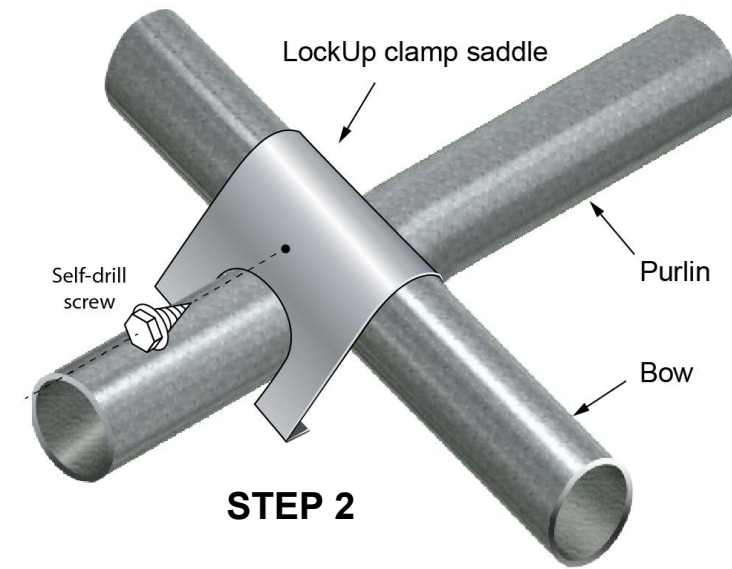
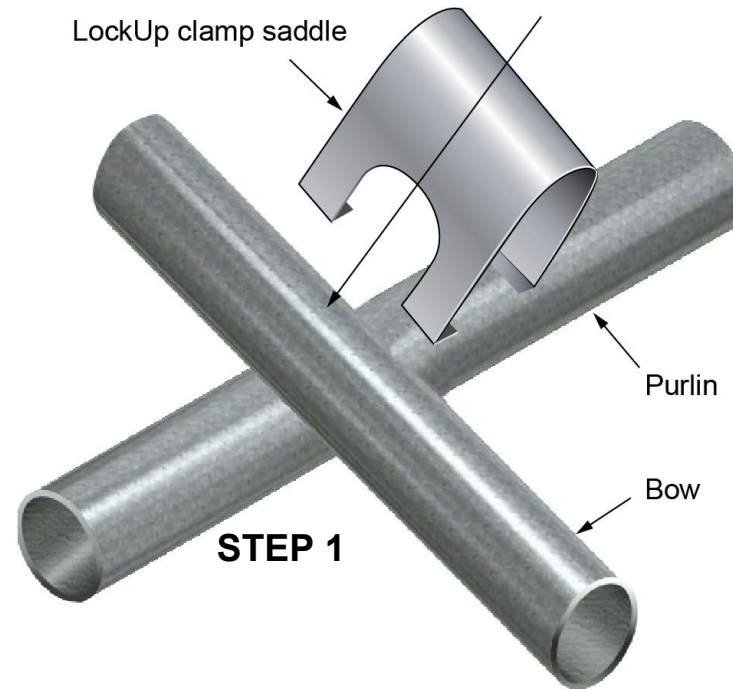

PURLIN SPLICE DETAIL

Gable Wall Connection Details

